

# Simulation of a Low-capacity Solar MSF Desalination Unit for a Steam Power Plant by Thermoflow Software

N. Mehtari<sup>1</sup>, M. Kahani<sup>1\*</sup>, and M. Zamen<sup>2</sup>

1. Faculty of Chemical and Materials Engineering, Shahrood University of Technology, Shahrood, Iran.  
2. Faculty of Mechanical Engineering, Shahrood University of Technology, Shahrood, Iran.

Received Date 09 July 2023; Revised Date 10 August 2023; Accepted Date 24 August 2023

\*Corresponding author: mostafa.kahani@shahroodut.ac.ir (M. Kahani)

## Abstract

The current research work focuses on the utilization of three waste water streams from a power plant located in southwestern Iran for desalination purposes, and to prevent the waste of heat from the boiler blowdown stream while reducing carbon dioxide emissions by pre-heating the cooling water. Three different scenarios are simulated using the Thermoflow-GT master 23 software, considering the conditions of power plant. The optimal values for the top brine temperature (TBT) of cooling water and the mass flow rate of the hot steam are selected by sensitivity analysis. The premier scenario consists of eight stages, with five stages dedicated to heat recovery (HGS) and three stages for heat rejection section (HRS). The optimal value for the TBT of cooling water is determined to be 90 °C; the produced freshwater capacity in the desalination unit is found to be 1.69 kg/s, and the gain output ratio (GOR) of the system is about 3.60. The proposed unit requires 0.47 and 10.15 kg/s of hot steam and cooling water, respectively, and the overall heat transfer coefficient is 2069.2 W/m<sup>2</sup> °C. In addition, the feasibility of utilizing a solar farm to generate the necessary thermal energy for the system is being evaluated.

**Keywords:** Low-capacity MSF desalination; Steam power plant; Energy recovery; simulation; Thermoflow-GT master 23 software.

## 1. Introduction

Due to the unequal geographical distribution of water resources, insufficient availability, industrialization, and subsequent water pollution, desalination, and wastewater treatment have emerged as viable alternatives for meeting the water demands of humanity. Desalination, as a strategic and impactful industry, has gained popularity since the 1950s with the development of desalination plants in countries facing severe challenges and meeting this vital human need. According to the International Desalination Association (IDA) report, in February 2020, approximately 21000 desalination plants have been built or contracted, producing 97.2 Mm<sup>3</sup> of fresh water per day. Additionally, in 2021, the market for reuse of wastewater reached an unprecedented record capacity of 16 Mm<sup>3</sup>/day, with an annual share of 46% of this capacity have been contributed by a plant in Egypt [1].

In general, in power plants, water is directed to the boiler using high-pressure pumps. After heating, it goes to the steam turbine connected to the generator, which ultimately results in the

production of electrical energy. During this process, steam loses its energy and becomes liquid by passing through the condenser. Water usage in power plants includes water used in the steam cycle, cooling systems, condensers, hot and cold blowdown in the cooling tower, regeneration of the water treatment system, and chemical cleaning of the boilers. The water used in power plants has impurities of less than 7000 part per million (ppm), which is much lower than the salinity of seawater. Therefore, the cost of fresh water will be lower. In addition, the wastewater in power plants usually has high temperatures, and by recovering the wasted energy from these streams, it is possible to supply the necessary energy for treating the power plant wastewater.

Desalination methods are divided into two categories of thermal and membrane technologies. Thermal technology, which involves a phase change, requires more mechanical and thermal energy compared to membrane processes and includes multi-stage flash distillation (MSF), multi-effect distillation (MED), and mechanical

vapor compression (MVC) methods. Among all the technologies, reverse osmosis and multi-stage distillation constitute the highest desalination capacity in the global market, which MSF desalination being widely used in the Middle East, areas adjacent to the Gulf, and regions with access to abundant low-cost energy.

The researchers have investigated application of renewable energy to produce thermal and electrical power by solar [2–5], wind energy [6], and also hydrogen generation [7-9]. The research results in Saudi Arabia with a combined unit consisting of a solar collector, an MSF desalination system, and two thermal storage tanks, conducted by Alsehli *et al.* [10], showed that a solar collector area of 1.92 m<sup>2</sup> is required to produce 19.7 kg of fresh water per day. In this unit, the cost of producing water was equal to 0.015 \$/L. Yang *et al.* [11] designed a multi-stage desalination system and a photovoltaic panel that showed high resistance against salt disposal, leading to the simultaneous production of electricity, heat, and fresh water. The results showed that the water yield using a five-stage stiller is approximately 1.17 kg/m<sup>2</sup>, and the electricity output is 97 W/m<sup>2</sup>. Zamen *et al.* [12] found that a new type of humidification-dehumidification (HDH) desalination unit in the MAKRAN coast of Iran requires a variable energy intensity of 3192-4382 kJ/L and a 96 m<sup>2</sup> solar collector to produce 1.25 L/m<sup>2</sup>.day with a GOR of 0.6. Zamen *et al.* [13] also developed a model for a direct HDH desalination unit, utilizing waste streams from a steam power plant. According to the best scenario and based on the availability of cooling water, the fresh water cost was 0.8 \$/m<sup>3</sup>, with a daily fresh water production of 7.5 m<sup>3</sup> while the GOR was 1.03.

According to the investigation carried out by Aboelmaaref *et al.* [14], linear parabolic trough technology has been the most effective method used in concentrated solar power plants since 2013, while linear reflectors were still limited in use and only employed in low-capacity facilities. Darawsheh *et al.* [15] conducted research on the combination of an MSF desalination unit and flat plate solar collectors with multi-stage chambers to produce fresh water. After selecting optimal and economical values for this system, the results showed that with a 20% reduction in atmospheric pressure in the chamber, the ratio of produced fresh water to evaporation increased by up to 53%, and specific energy consumption decreased by up to 35%. The best production-to-evaporation ratio was obtained at a feed flow rate of 0.5 L/min, which was equal to 0.42. Moussaoui *et al.*

[16] have mathematically modeled a solar MSF desalination system connected to four flat plate solar collectors. The area of each collector was 3 m<sup>2</sup>, and the results showed that the daily production of fresh water in this unit was 90 liters, which 29 liters of this amount are produced only in the first stage of the desalination unit and this amount is reduced to 13 kg in the final stage. Furthermore, the overall efficiency of the designed system was equal to 0.52 kg/m<sup>2</sup> hr.

Ghorbani *et al.* [17] designed a unit for the simultaneous production of fresh water and electricity. The designed unit consists of solar collectors, a Kalina cycle, and an MSF unit, which are used to provide thermal energy, electricity, and fresh water production, respectively. Sensitivity analysis was performed on basic parameters such as the number of collectors, mass flow rate, and molar composition of the Kalina cycle, and optimal values were considered for problem-solving. The production of 1869 kW of electricity, 65194 kW of heat, and 83.22 kg/s of fresh water are the outputs of their proposed system. Al-Othman *et al.* [18] evaluated an MSF plant powered by parabolic trough collectors and a solar pond. The aim of the simulation was to produce 1880 m<sup>3</sup>/day, where approximately 76% of the required energy for this plant was provided by 3160 m<sup>2</sup> of parabolic trough collectors, and the rest of the energy was supplied by a solar pond with a depth of 4 m and an area of 0.53 km<sup>2</sup>.

In a study performed by Sembitzky *et al.* [19], solar parabolic trough systems were mainly tested in the United States. For example, a factory using 48 kW of solar energy, produces 450 liters of fresh water per day using a three-stage process. Mendez and Bicer [20] designed a system consisting of a solar chimney, wind energy, and a combined MSF-RO desalination plant to simultaneously produce electricity and fresh water. The results of this study showed that the system produces 8.3 kg/s of fresh water and 81.7 kW of electricity using solar energy. Eladawy *et al.* [21] proposed a modified combined cycle consisting of a Rankine cycle and an MSF desalination unit, which is connected to a 50 MW of solar farm. The proposed system is capable of producing 130.6 MW of net electricity per month, 4950 m<sup>3</sup> of fresh water per day in the summer season, as well as 133.9 MW of net electricity and 3470 m<sup>3</sup> of fresh water per day in the winter season.

Kabiri *et al.* [22] conducted a research work on the application of solar energy in a thermal power plants and its combination with MSF plant. The produced fresh water in this unit was equal to

115.4 kg/s, and the GOR was 9.62. The amount of thermal and electrical energy consumption was 0.36 MW and 1.57 kW, respectively. The cost of water production was estimated to be 0.21 \$/m<sup>3</sup>. However, by using a steam recovery cycle with solar farm, the cost of water production can be further reduced. Wang *et al.* [23] designed and estimated a concentrated solar power and MSF desalination hybrid system using the super-critical carbon dioxide (S-CO<sub>2</sub>) Brayton cycle. The results showed that the electricity and daily fresh water production of the system are 50.1 MW and 4050.8 tons, respectively, and the Brayton cycle efficiency was 36.6%. The results of the study by Ghorbani *et al.* [24] on a system for simultaneous production of electricity, heat, and fresh water using a combination of flat plate solar collectors, MSF desalination unit, and Kalina power cycle showed that this structure is capable of producing 300 m<sup>3</sup>/hr of fresh water, 1300 m<sup>3</sup>/hr of hot water, and 1869 kW of electricity. Additionally, sensitivity analysis showed that by increasing the area of the collectors up to 60% while maintaining the flow rate constant, the energy required by the boilers could be reduced by up to 37%.

The current study aims to design a low-capacity MSF desalination unit by using the waste streams of the main power plant in Iranshahr. The high potential of solar energy in this region, a system for producing fresh water using the wastewater of this power plant and solar energy is being investigated to compensate for a portion of its water consumption. Three scenarios corresponding to the power plant conditions are simulated in Thermoflow software, and the results of the selected scenario are presented while considering the software limitations.

## 2. Process description

Iranshahr power plant, located in the southeastern region of Iran with a capacity of 740 MW, is one of the most important electricity generating plants in Iran. In this study, three main wastewater streams of the Iranshahr power plant are investigated including the salt water, the cooling tower, and the boiler blowdown streams. The salt water stream, which is the main target for desalination, has a temperature of 35 °C and a mass flow rate of 150 m<sup>3</sup>/day. This stream, which was primarily designed for desalination feed, is associated with chemical washing units that are used for reviving filters and washing various equipment and pipes. The cooling tower blowdown stream also has a temperature of 35 °C and a flow rate of 720 m<sup>3</sup>/day, which is used to cool the desalination system. Moreover, the boiler

blowdown stream has a temperature of 100 °C and a mass flow rate of 192 m<sup>3</sup>/day, which is used to heat the feed stream of the plant. It is worth noting that using the waste energy of the power plant can prevent additional fuel consumption and save related costs, which will have a significant environmental impact in reducing carbon dioxide emissions. Chemical analysis of the three-wastewater streams shows that the salt content in the salt water and cooling tower streams are 5750 and 230.5 mg/L, respectively. Additionally, the boiler blowdown is assumed pure.

As shown in figure 1, the MSF desalination unit consists of two parts, namely the heat rejection (HRS) and heat recovery sections (HGS). The desalination unit is composed of several chambers suitable for sudden evaporation; each of these contains a heat exchanger tube bundle, demister, distillate tray, brine pool, and submerged orifice to reduce the inlet flow pressure. In general, the MSF desalination process in an industrial unit proceeds as follows: the target stream for salt removal enters the process from the last stage and is preheated by the heat generated from the evaporation of fresh water in each stage. After removing a portion of this water for heat balancing in the HRS and mixing it with the return stream from the last stage of the unit, the remaining stream enters the HGS and then exits the first stage, and enters a heater to raise the final temperature. The stream is prepared for the evaporation process and in each stage, sudden evaporation occurs with a decrease in pressure and temperature compared to the previous stage, and the desalinated water vapor is condensed and collected in the distillate water tray of each stage. The remaining brine enters the next stage, and the evaporation and condensation process is repeated similarly to the previous stage, continuing until a complete cycle is reached. The application of this technology, along with combined cycle power plants, for the supply of high-volume fresh water is very cost-effective and easy to manage.

## 3. Simulation of MSF desalination unit in thermoflow

Thermoflow software is the most specialized program for power plant simulation and heat balance analysis. This software has various modules that are designed for specific functions. One of the most important modules is the GT master module, which is used for designing desalination systems. Initially, the MSF model was selected for this design, and then the power plant capacity, as well as parameters such as temperature, ambient pressure, and relative

humidity, was determined for the software. These values were set at 35 °C, 1.013 bar, and 70%

based on the software's default settings in the Middle East.

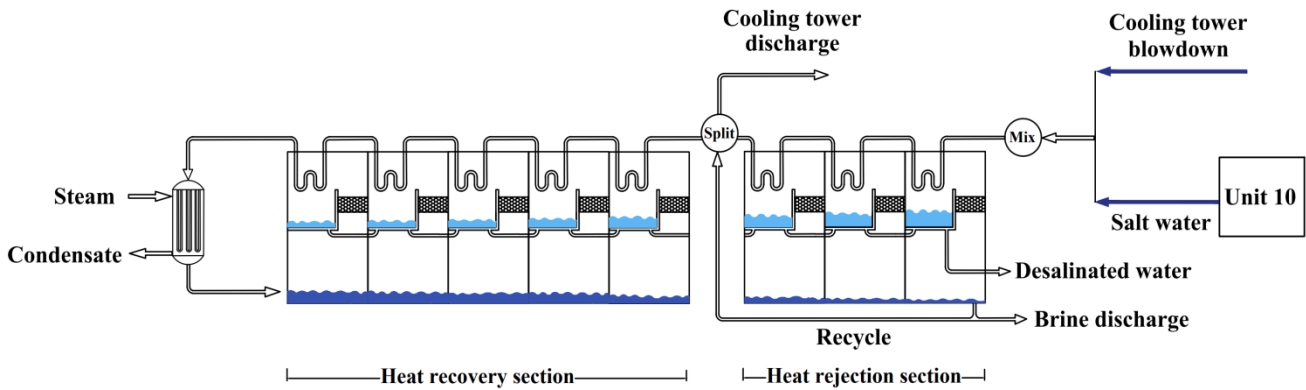


Figure 1. Schematics of proposed MSF unit.

To design the desired system, information can be provided to the software by specifying either the inlet steam flow rate or the outlet desalinated water flow rate. In the designed system, the initial value of hot steam is 0.47 kg/s. Then a low-pressure state was used to adjust the steam source to achieve a hot steam pressure of 1 bar. The vacuum system steam source is the next parameter that needs to be determined. Its temperature and pressure manually were set to their minimum values of 138.3 °C and 3.447 bar, respectively. The seawater temperature was also set to 35 °C based on the information provided by the power plant. Additionally, to determine the feed water salinity percentage, there is a minimum limit of 10000 ppm in the software, and the primary value of this parameter cannot be set.

There are important factors to consider in designing the desalination unit and determining the optimal operating conditions of the system, such as performance ratio, gain output ratio, and energy intensity. The Performance Ratio (PR) represents the efficiency of the desalination system, and an increase in PR results in higher production of fresh water, and consequently, an increase in the required number of stages, leading to higher costs. This parameter is given by equation (1).

$$PR = \frac{\text{kg of distilled water}}{2326 \text{ kJ of consumed heat}} \quad (1)$$

The Gain Output Ratio (GOR) is given by equation (2). It indicates the ratio of water produced per unit of steam consumption. The value of this coefficient can range from 1 to 10, depending on the available energy in the region of interest, and higher values are applicable for regions with high energy costs or severe water shortages. An increase in this coefficient leads to

higher production of fresh water and an increase in the initial cost of the desalination unit.

$$GOR = \frac{\text{kg of distilled water}}{\text{kg of consumed steam}} \quad (2)$$

The Recovery Ratio (RR) parameter is the ratio of the produced water to the feed water flow rate and is calculated using equation (3). This parameter indicates the percentage of fresh water recovery in the desalination process. The energy intensity parameter is calculated by equation (4) as the sum of electrical and thermal energy at the software output, divided by the produced fresh water flow rate, and is expressed in kJ/kg.

$$RR = \frac{\text{Product flow rate}}{\text{Feed flow rate}} \times 100 \quad (3)$$

$$\text{Energy intensity} = \frac{\text{Electrical power} + \text{Thermal power}}{\text{kg of distilled water}} \quad (4)$$

In this system, the hot steam flow rate and the top brine temperature were set 0.47 kg/s and 90 °C, respectively, to obtain a smaller desalination plant. The goal of the desalination process in this study is to treat on a mixed stream consisting of a feed water flow rate of 150 m<sup>3</sup>/day of seawater and a cooling tower flow rate of 700 m<sup>3</sup>/day. These two streams are mixed and enter into the desalination unit as the cooling water stream. The available steam flow rate for heating this stream is declared to be 192 m<sup>3</sup>/day, equivalent to 2.22 kg/s. There are limitations in inputting accurate power plant information into the Thermoflow23 software. The salt concentration of the feed stream is about 6000 ppm, but the software cannot accept a value of less than 10000 ppm. This ultimately leads to an increase in the required cooling water flow rate for the desalination unit. Based on the conducted investigations and observed changes in

the parameters, three desirable and close-to-actual power plant conditions will be explained in the following sections.

**4. Results and discussion**

**4.1. Scenario I: using full steam capacity generated by boiler blowdown**

The first scenario is presented based on the available steam flow rate of 2.22 kg/s in the power plant. As can be seen in table 1, if all of this amount is utilized, the required cooling water flow rate for the desalination process will be 38.39 kg/s, which considerably differs from the available parameter in the power plant, which is 9.84 kg/s. The seawater temperature is heated up to 90 °C in the first stage and decreased to 67.74 °C in the final stage. The produced water in this scenario is 6.40 kg/s, the outlet brine blowdown is 31.99 kg/s. The GOR and energy intensity of the designed unit are 2.88 and 955.84 kJ/kg, respectively.

**4.2. Scenario II: minimum steam capacity in software (premier scenario)**

The closest and best scenario occurs when the inlet steam pressure for heating is equal to 1 bar,

the required steam is 0.47 kg/s, the TBT and the cooling water temperature are 90 and 35 °C, respectively, and its salinity is 10000 ppm. As shown in table 1, by examining the software outputs in this scenario, it is determined that the required cooling water for the unit is minimized and equal to 10.15 kg/s, and the produced water flow rate is 1.69 kg/s. The designed MSF desalination unit consists of eight stages, with five stages in the HGS and three stages in the HRS. The GOR of this unit is 3.60, and its energy intensity is 782.4 kJ/kg.

**4.3. Scenario III: minimum steam and decreasing cooling water temperature**

According to the findings presented in table 1, if the temperature of the cooling water supplied to the system is lowered to 30 °C during colder months, it can result in several changes. These changes include an increase in GOR up to 3.73, as well as an increase in production and required cooling water by 1.75 and 10.52 kg/s, respectively. Moreover, the temperature of the brine stream in the final stage of the process decreases. It should be noted that this scenario involves an eight-stage configuration (5+3) and has an energy intensity of 754.73 kJ/kg.

**Table 1. Specification of all scenarios.**

Scenarios	1st stage Temperature (°C)	Final stage Temperature (°C)	Steam (kg/s)	Desalinated water (kg/s)	Cooling water (kg/s)	Brine blowdown (kg/s)	GOR
I	90	67.74	2.22	6.40	38.39	31.99	2.88
II		61.54	0.47	1.69	10.15	8.46	3.60
III		55.7		1.75	10.52	8.76	3.73

The recovery ratio of all mentioned scenarios is about 16.67%, and the input and output streams for all three studied scenarios are schematically shown in figure 2.

The available input values for each scenario and the comparison of the three studied scenarios are shown in table 2. In Scenario (I), all the available steam capacity of the power plant is utilized, but the required amount of cooling water is four times much more than the available amount. In scenario (III), compared to scenarios (I) and (II), a higher GOR was achieved, along with a decrease in the temperature of the brine stream at the final stage. However, considering that the Iranshahr power plant is located in an area where the minimum temperature is approximately 35°C, scenario (III) has been rejected because it is not possible to reduce the temperature of the input feed to 30 °C. The graphical output of the premier scenario (scenario II) is illustrated in figure 3.

In the proposed desalination plant by Thermoflow, the use of stainless steel pipes is recommended due to the existence of saltwater and corrosion. However, for the brine heater CuNi 70-30 pipes with an outer diameter of 15.88 mm are recommended. For HGS, Thermoflow suggests CuNi 90-10 pipes with a diameter 15.88 mm diameter and for HRS titanium pipe with an outer diameter of 12.7 mm.

**4.4 Sensitivity analysis for premier scenario**

To determine the optimal values for the desalination unit based on the premier scenario, sensitivity analysis has been performed on the influential parameters affecting the results, including the TBT, the steam flow rate, and the salinity of the cooling water stream. The constant parameters are presented in table 3.

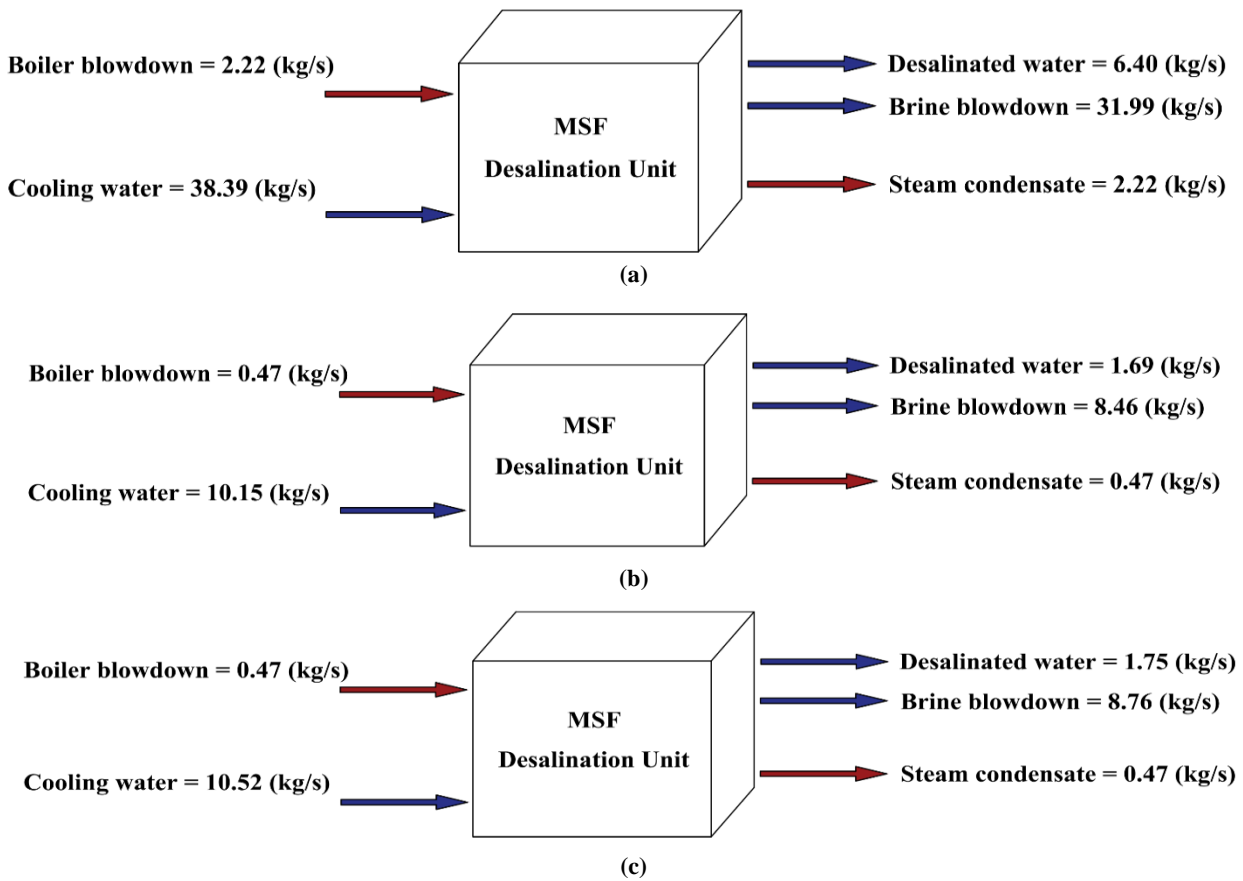


Figure 2. Input and output stream values of (a) scenario I, (b) scenario II, and (c) scenario III.

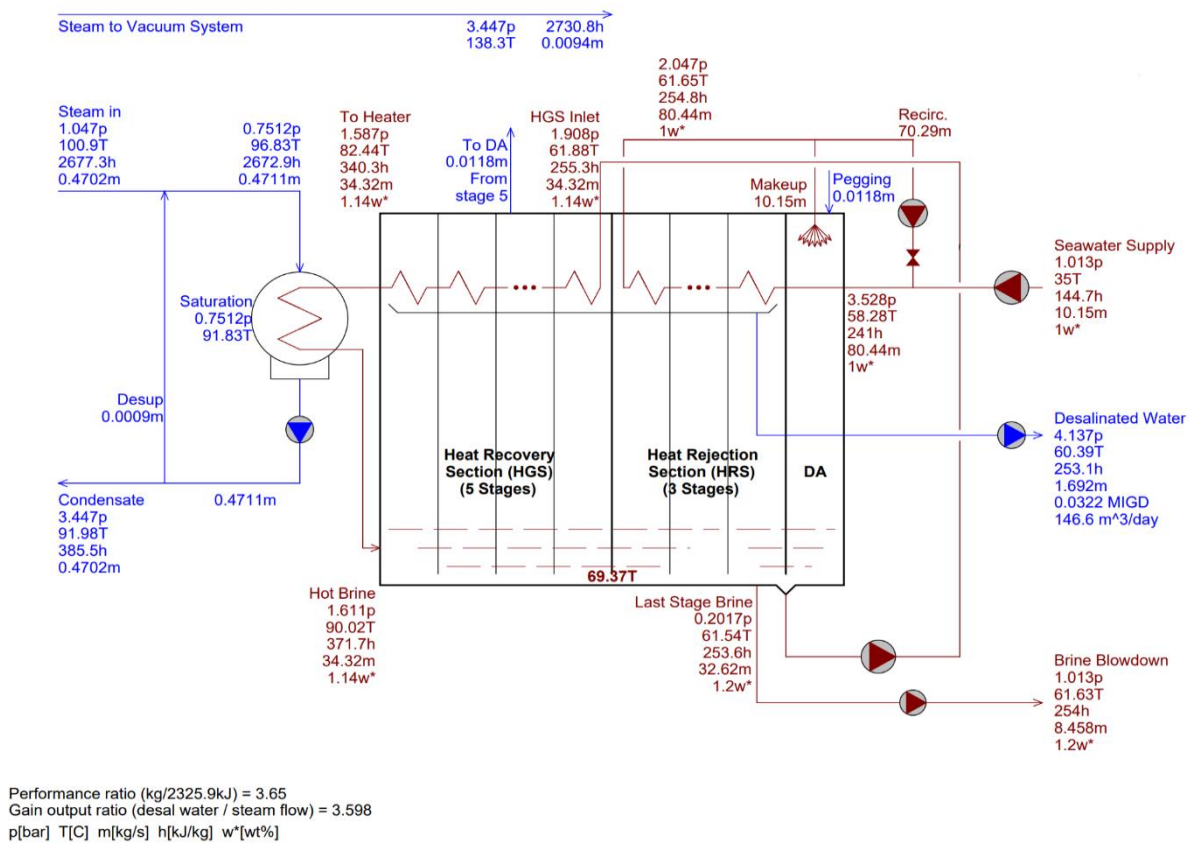


Figure 3. Thermoflow graphical output for the premier scenario.

**Table 2. Required steam available and required cooling water for each scenario.**

# Scenario	Required steam (kg/s)	Available cooling water (kg/s)	Required cooling water (kg/s)
I	2.2	9.84	38.39
II	0.47		10.15
III	0.47		10.52

**Table 3. Fixed parameters for sensitivity analysis.**

Parameter	Value
Pipe pressure drop (bar)	1.034
Steam pressure (bar)	1.047
Steam temperature (°C)	100.9
Cooling tower temperature (°C)	35
Salt concentration (ppm)	10000
Brine blowdown concentration (ppm)	12000

**Effect of TBT**

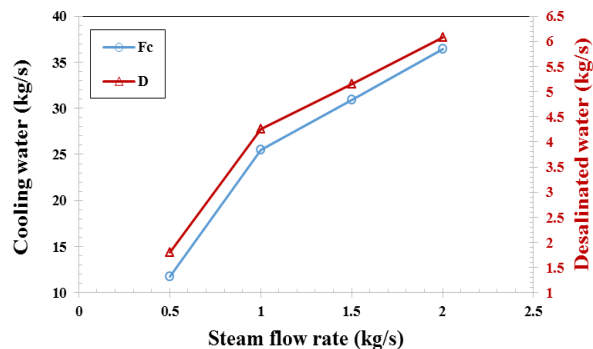
As shown in table 4, increasing the TBT from 85 to 95 °C resulted in an increase in fresh water produced from 1.62 to 1.78 kg/s. The number of stages does not change, and for all three streams, there is a need of eight stages. On the other hand, it is observed that increasing TBT requires less energy intensity about 77.5 kJ/kg for MSF units.

**Table 4. Effect of top brine temperature.**

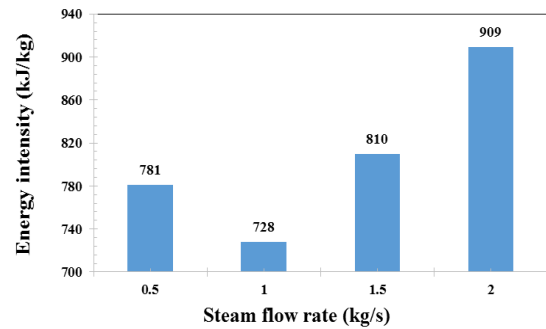
TBT (°C)	85	90	95
No. of stages	8 (5+3)		
Desalinated water (kg/s)	1.62	1.69	1.78
Seawater supply (kg/s)	10.70	10.14	10.70
Recovery ratio	15.07		16.67
GOR	3.441	3.596	3.795
Energy intensity (kJ/kg)	818.78	782.40	741.30

**Effect of steam flow rate**

Figure 4 shows the effect of the steam flow rate on the fresh water production and cooling water flow rate. The results indicate that the input steam does not affect the number of stages but increases the amount of produced fresh water from approximately 1.8 to 6.07 kg/s, which requires more cooling water about 11.71 to 36.44 kg/s. As can be seen in figure 5, in this case, the energy intensity changes between 728 and 909 kJ/kg.



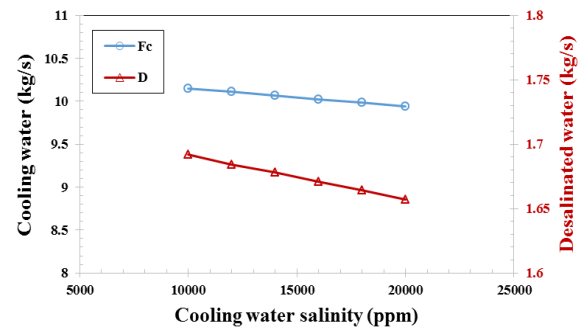
**Figure 4. Effect of steam flow rate on fresh water production and required cooling water.**



**Figure 5. Effect of steam flow rate on energy intensity.**

**Effect of cooling water salinity**

As can be seen in figure 6, when the salinity of the cooling water increases from 10000 to 20000 ppm, the produced fresh water and the required water for cooling will decrease, leading to a decrease in the GOR from 3.723 to 3.576, and a decrease in energy intensity from 798.50 to 756.35 kJ/kg. The required number of stages remains constant by changing the cooling water salinity.



**Figure 6. Effect of salinity on fresh water production and required cooling water.**

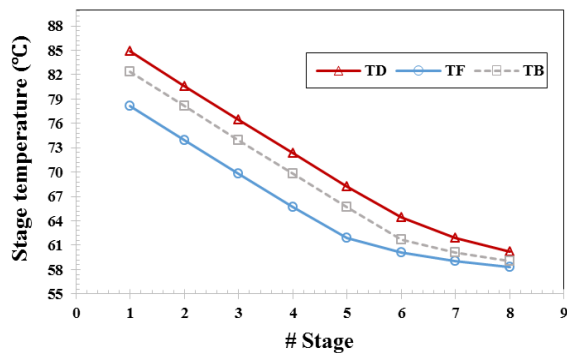
According to the explanations given in this section, all three investigated parameters, i.e. TBT, the steam flow rate, and the salinity of the cooling water stream, are influential parameters on the performance of the desalination system. The summary of the final results is presented in table 5. It worth mentioning that MSF desalination plants are commonly employed on a large capacity due to their ability to utilize thermal energy and handle a low amount of effluent flow. The GOR values in conventional MSF desalination plants can range from 4 to 10. A higher GOR coefficient indicates a greater need for cooling water, more stages in the desalination process, and a higher initial cost. However, this ultimately leads to increased fresh water production. Since in this simulation, a low-capacity MSF desalination system has been

proposed, so a smaller value of GOR is obtained compared to conventional MSF systems.

**Table 5. Final results of the MSF desalination unit based on premier scenario.**

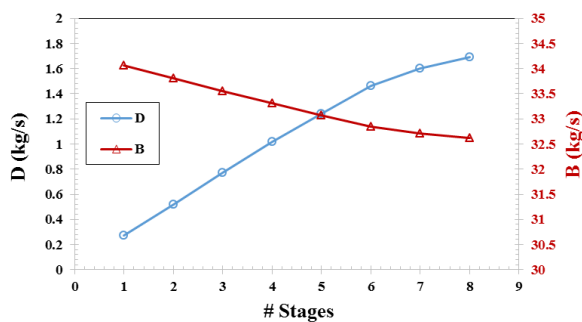
Steam flow rate (kg/s)	Required cooling water (kg/s)	Desalinated water (kg/s)	Energy intensity (kJ/kg)	Required heat transfer area (m <sup>2</sup> )	GOR	RR
0.47	10.15	1.69	782.40	550.6	3.60	16.67

After determining the optimal values for the premier scenario, which are TBT = 90 °C and eight (5+3) stages, and the required amount of hot steam is 0.47 kg/s, the temperatures for each stage including brine, distillate, and cooling water were specified in figure 7. As observed, the brine temperatures for stages 1 to 8 decreased from 82.4 to 59 °C, the distillate temperature decreased from about 85 to 60 °C and the cooling water temperature decreased from approximately 78 to 58 °C.

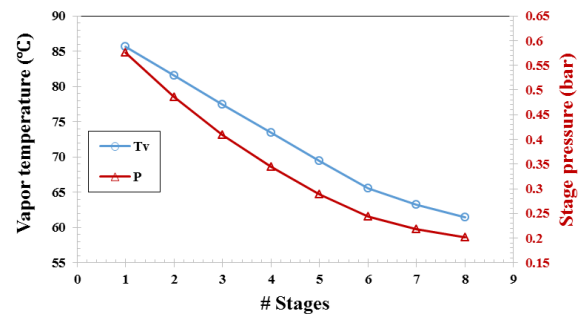


**Figure 7. Cooling water, distillate, and flashing brine temperature on each stage.**

The values of brine and distillate flow rates for each stage are shown in figure 8, As seen in this figure, from stages 1 to 8, the brine value decreases from about 34 to 32.62 kg/s, while the distillate value increases from 0.27 to 1.69 kg/s. It is worth mentioning that the final distillate value is equal to the sum of all stage outputs. Additionally, in figure 8, the vapor temperature and pressure for each stage are visible, and with a decrease in pressure from 0.57 to 0.20 bar, the vapor temperature also decreases from 85.7 to 61.5 °C creating conditions for sudden evaporation in the chamber.



**Figure 8. Distillate and flashing brine flow rate on each stage.**



**Figure 8. Vapor temperature and pressure change in each stage.**

### 4.5. Application of solar energy

Co-generation plants employed by MSF utilize natural gas as the primary fuel for electricity and fresh water production. However, due to the increasing global temperatures resulting from the use of fossil fuels, it may be beneficial to utilize the readily available solar energy in suitable regions. The cost of producing water from solar-driven MSF desalination was determined to be within the range of 1-5 \$/m<sup>3</sup> [24].

Parabolic trough solar collectors are utilized in various applications, such as industrial steam generation and hot water production. These collectors are preferred for steam generation using solar energy because they can reach high temperatures without a significant reduction in efficiency. The linear collector has a trough-shaped cross-section with a parabolic curve, and it is fitted with a mechanical control mechanism that adjusts the position of the reflective surface so that it faces the sun at all times during the day.

The reflective surface of the linear collector focuses the sunlight onto a pipe located at the center of the curved shape. This causes the heat transfer fluid inside the pipe to heat up. Typically, linear parabolic trough collectors have concentration ratios ranging from 10 to 100, which leads to operating temperatures of about 100-400 °C. Thus this method can reach much higher temperatures compared to flat plate or evacuated tube collectors.

Based on the results obtained for the premier scenario, it is recommended to use a linear parabolic trough solar collector system to provide the necessary thermal energy for steam production at a rate of 0.47 kg/s, equivalent to 1324 kW, in the MSF desalination unit. This solution allows



for low-pressure steam production. For this approach, a collector area of 4035 m<sup>2</sup> is required for a fresh water capacity of 146.6 m<sup>3</sup>/day.

## 5. Conclusion

This study aimed to design a low-capacity MSF desalination unit coupled with a power plant. The optimal and closest scenario to the conditions of the Iranshahr power plant is considered and, a simulation was run in the ThermoFlow-GT master 23 software. The three wastewater streams from the power plant were utilized in this study, and energy savings were achieved due to the use of the waste heat from the hot steam boiler stream. This factor resulted in reducing the costs of the desalination unit and preventing the production of additional carbon dioxide. Three scenarios were examined, for the premier scenario, sensitivity analysis was performed based on the available hot steam and cooling water, and optimal values for the fundamental parameters were determined. The produced capacity of this eight-stage MSF unit is 1.69 kg/s, requiring of 0.47 kg/s hot steam and 10.15 kg/s of cooling water. The GOR and energy intensity in this state are 3.60 and 782.40 kJ/kg, respectively. If the thermal energy needed is obtained from solar power, then the linear parabolic trough solar collector system can be utilized. 4035 m<sup>2</sup> of parabolic solar collectors is required for production of 146.6 m<sup>3</sup>/day of fresh water.

## 6. References

- [1] H. Birch, *Desalination & Reuse Handbook 2022-2023*. 2023.
- [2] T. Taner, A. S. Dalkilic, "A Feasibility study of solar energy-techno economic analysis from Aksaray city , Turkey," 2017.
- [3] H. Eshghi, M. Zamen, and M. Kahani, "Energy and environmental investigation on photovoltaic system performance by application of square cross - sectional two - phase closed thermosyphon," *Environ. Sci. Pollut. Res.*, 2023, doi: 10.1007/s11356-023-27865-7.
- [4] H. Eshghi, M. Kahani, and M. Zamen, "Cooling of Photovoltaic Panel Equipped with Single Circular Heat Pipe : an Experimental Study," doi: 10.22044/rera.2022.11523.1097.
- [5] M. Zamen, M. Kahani, B. Rostami, and M. Bargahi, "Application of Al<sub>2</sub>O<sub>3</sub>/water nanofluid as the coolant in a new design of photovoltaic/thermal system: An experimental study," *Energy Sci. Eng.*, doi: 10.1002/ese3.1067.
- [6] T. Taner, "Economic analysis of a wind power plant: A case study for the Cappadocia region," *J. Mech. Sci. Technol.* , doi: 10.1007/s12206-018-0241-6.
- [7] T. Taner, S. A. H. Naqvi, and M. Ozkaymak, "Techno-economic Analysis of a More Efficient Hydrogen Generation System Prototype: A Case Study of PEM Electrolyzer with Cr-C Coated SS304 Bipolar Plates," *Fuel Cells*, doi: 10.1002/face.201700225.
- [8] Syed Arslan Hassan Naqvi, Tolga Taner, Mehmet Ozkaymak, and Hafiz Muhammad Ali, "Hydrogen Production through Alkaline Electrolyzers: A Techno-Economic and Environmental Analysis", *Chemical Engineering Technology*, 8- <https://doi.org/10.18186/journal-of-thermal-engineering.331755>.
- [9] T. Taner, "The micro-scale modeling by experimental study in pem fuel cell," *Journal of Thermal Engineering*, December 2017, doi.org/10.18186/journal-of-thermal-engineering.331755.
- [10] M. Alsehli, J. Choi, and M. Aljuhan, "A novel design for a solar powered multistage flash desalination," *Sol. Energy*, doi: 10.1016/j.solener.2017.05.082.
- [11] L. Yang et al., "Photovoltaic-multistage desalination of hypersaline waters for simultaneous electricity, water and salt harvesting via automatic rinsing," *Nano Energy*, doi: 10.1016/j.nanoen.2021.106163.
- [12] M. Zamen, M. Kahani, and G. Zarei, "Seawater Greenhouse Equipped with a Novel Solar Humidification-Dehumidification Desalination Unit in MAKRRAN Coast: Fabrication and Experimental Study," *Water (Switzerland)*, doi: 10.3390/w15030539.
- [13] M. Zamen, M. Kahani, J. Yazdanpanahi, R. Abedini, and M. H. Ahmadi, "Modeling of a direct-contact humidification-dehumidification desalination unit in a 256 MW steam power plant using effluent streams: Case study," *Case Stud. Therm. Eng.*, doi: 10.1016/j.csite.2023.102966.
- [14] M. M. Aboelmaaref, "Hybrid solar desalination systems driven by parabolic trough and parabolic dish CSP technologies: Technology categorization, thermodynamic performance and economical assessment," *Energy Convers. Manag.*, doi: 10.1016/j.enconman.2020.113103.
- [15] I. Darawsheh, M. D. Islam, and F. Banat, "Experimental characterization of a solar powered MSF desalination process performance," *Therm. Sci. Eng. Prog.*, doi: 10.1016/j.tsep.2019.01.018.
- [16] N. El Moussaoui and K. Kassmi, "Modeling and Simulation studies on a multi-stage solar water desalination system," *Proc. 2019 Int. Conf. Comput. Sci. Renew. Energies, ICCSRE 2019* , doi: 10.1109/ICCSRE.2019.8807623.

- [17] B. Ghorbani, M. Mehrpooya, and M. Sadeghzadeh, "Developing a tri-generation system of power, heating, and freshwater (for an industrial town) by using solar flat plate collectors, multi-stage desalination unit, and Kalina power generation cycle," *Energy Convers. Manag.*, December 2017, doi: 10.1016/j.enconman.2018.03.040.
- [18] A. Al-Othman, M. Tawalbeh, M. El Haj Assad, T. Alkayyali, and A. Eisa, "Novel multi-stage flash (MSF) desalination plant driven by parabolic trough collectors and a solar pond: A simulation study in UAE," *Desalination*, doi: 10.1016/j.desal.2018.06.005.
- [19] W. Teplitz-Sembitzky, "The use of Renewable Energies for Seawater Desalination - a Brief Assessment Technical Information W10e," *Tech. Inf.*
- [20] C. Méndez and Y. Bicer, "Integrated system based on solar chimney and wind energy for hybrid desalination via reverse osmosis and multi-stage flash with brine recovery," *Sustain. Energy Technol. Assessments*, February 2021, doi: 10.1016/j.seta.2021.101080.
- [21] M. . Eladawy, E. Elgendy, and S. Shaaban, "Performance Enhancement of an Integrated Solar Combined Cycle with Multi-Stage Flash Desalination Cycle as Bottoming Cycle," *Eng. Res. J.*, doi: 10.21608/erj.2020.132139.
- [22] S. Kabiri, M. H. Khoshgoftar Manesh, M. Yazdi, and M. Amidpour, "New procedure for optimal solar repowering of thermal power plants and integration with MSF desalination based on environmental friendliness and economic benefit," *Energy Convers. Manag.*, March 2021, doi: 10.1016/j.enconman.2021.114247.
- [23] G. Wang, B. Dong, and Z. Chen, "Design and behaviour estimate of a novel concentrated solar-driven power and desalination system using S-CO<sub>2</sub> Brayton cycle and MSF technology," *Renew. Energy*, doi: 10.1016/j.renene.2021.05.091.
- [24] B. Ghorbani, M. Mehrpooya, and M. Sadeghzadeh, "Developing a tri-generation system of power, heating, and freshwater (for an industrial town) by using solar flat plate collectors, multi-stage desalination unit, and Kalina power generation cycle," *Energy Convers. Manag.*, March 2018, doi: 10.1016/j.enconman.2018.03.040.